

Product Manual

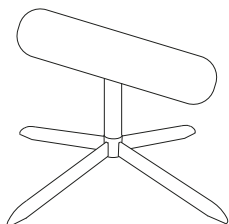
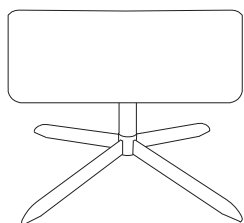

Saga Footstool
Designed by Anna & Signe

Version 002 - July / 2023

BOLIA

Vaerkmestergade 11-13
8000 Aarhus C, Denmark
+45 51 50 51 22

GB

Read the product manual carefully before using your product. If you do not follow the instructions, there is a risk that you could damage the product or in the worst case cause injury. Keep the product manual for future reference. If the product is later passed on to third parties, this manual must also be provided.



This symbol indicates a warning regarding the care, handling, or use of the product. If such a warning is not followed, there is a risk that you could damage the product, or in the worst case cause injury.

Use the product only for the purpose described in this manual. Any other use does not correspond to the intended purpose of the product and can lead to damage to the product or injuries. The manufacturer or dealer accepts no responsibility for damage resulting from the use of the product in a manner for which it is not intended. Incorrect, improper use of the product can lead to personal injuries. Children must not play with the packaging film, as there is a risk that they will be wrapped up in it and caught. Before using the product, make sure that there is nothing that can harm or injure people.

Risk of damaging the product

Incorrect, improper use, handling and cleaning can damage parts or the entire product.

Do not step on or jump on the product. It is not intended for this.

Do not use a hard brush, solvent, corrosive or strong cleaning agent to clean the products, if not advised by Bolia.com.

Always use recommended care and cleaning products.

Never cover wet products. If a wet product is covered, it can be damaged.

Further information can be found on our website: Bolia.com

Technical information

As we are constantly developing and improving our products, design and technical changes may occur. This products manual can be downloaded as a PDF file from our website: Bolia.com



Disposal of packaging & product

Dispose of the product and packaging in accordance with local waste regulations.

Packaging materials must be separated and disposed of properly.

For user instructions in other languages,
please scan this code





GB: Please tighten the screws/legs after 4-5 weeks of use and then subsequently every 4-5 month.

DK: Spænd skruerne/benene efter 4-5 ugers brug og derefter hver 4.-5. måned

DE: Ziehen Sie die Schrauben/Beine nach 4 bis 5 Wochen Gebrauch und anschließend alle 4 bis 5 Monate nach.

NO: Stram skruene/bena etter 4–5 ukers bruk, og deretter hver 4.–5. måned

SE: Dra åt skruvarna/benen efter 4–5 veckors användning och därefter var 4–5:e månad

NL: Draai de schroeven/poten na 4-5 weken gebruik aan en vervolgens elke 4-5 maanden.

FR: Veuillez resserrer les vis/pieds après 4 à 5 semaines d'utilisation, puis tous les 4 à 5 mois suivants.

ES: Aprieta los tornillos/patas después de 4-5 semanas de uso y posteriormente cada 4-5 meses



GB: Tested for 110 kg/242 lbs. Only trained personnel may replace or repair components.

DK: Testet til 110 kg/242 lbs. Kun uddannet personale må udskifte eller reparere komponenter.

DE: Geprüft auf 110 kg. Nur geschultes Personal darf Komponenten.

NO: Testet for 110 kg/242 lbs. Kun opplært personell kan skifte ut eller reparere komponenter.

SE: Testad för 110 kg. Endast utbildad personal får byta ut eller reparera komponenter.

NL: Getest voor 110 kg/242 lbs. Alleen opgeleid personeel mag onderdelen vervangen of repareren.

FR: Testé pour 110 kg/242 lbs. Seul le personnel professionnel formé est autorisé à remplacer ou à réparer les composants.

ES: Probado para 110 kg. La sustitución o reparación de los componentes las realizará exclusivamente personal debidamente formado.



GB: This product is only for indoor use.

DK: Dette produkt er kun til indendørs brug.

DE: Dieses Produkt darf nur in Innenräumen verwendet werden.

NO: Dette produktet er kun ment for innendørs bruk.

SE: Den här produkten är endast avsedd för inomhusbruk.

NL: Dit product is uitsluitend bedoeld voor gebruik binnenshuis.

FR: Ce produit est uniquement destiné à un usage intérieur.

ES: Aquest producte només es pot fer servir a l'interior

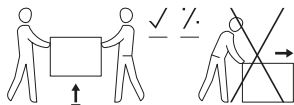

GB: Do not push or drag furniture across the floor – please lift when moving.

DK: Skub eller træk ikke møbler hen over gulvet – løft dem, når du flytter dem.

DE: Schieben oder ziehen Sie Möbel nicht über den Boden – heben Sie sie bitte an, wenn Sie sie bewegen.

NO: Ikke skyv eller trekk møblene over gulvet – løft dem når de skal flyttes.

SE: Skjut eller dra inte möbler över golvet – lyft dem vid flytt.

NL: Duw of sleep meubels niet over de vloer – til ze op wanneer u ze verplaatst.

FR: Ne pas pousser ou traîner les meubles sur le sol – veuillez les soulever lorsque vous les déplacez.

ES: No empujes ni arrastres muebles por el suelo, levántalos cuando los muevas.

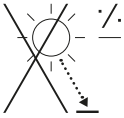

GB: Do not place the furniture in direct sunlight.

DK: Placer ikke møblet i direkte sollys.

DE: Setzen Sie die Möbel nicht direktem Sonnenlicht aus.

NO: Ikke plasser møbelet i direkte sollys.

SE: Placera inte möbeln i direkt solljus.

NL: Plaats het meubelstuk niet in direct zonlicht.

FR: Ne placez pas le meuble à la lumière directe du soleil.

ES: No expongas el mueble a la luz solar directa.



GB: DANGER OF TIPPING OVER – do not use furniture as a climbing assist

DK: FARE FOR AT VÆLTE – brug ikke møbler som klatrehjælp

DE: KIPPGEFAHR – Möbel nicht als Aufstiegshilfe verwenden

NO: VELTEFARE – ikke bruk møblene som klatrehjelp

SE: TIPPRISK – använd inte möbler som klättringshjälp

NL: KANTELGEVAAR – gebruik meubels niet als

FR: RISQUE DE BASCULEMENT – ne pas utiliser les meubles comme accessoires pour grimper ou accéder à des objets en hauteur

ES: PELIGRO DE VUELCO: no utilices los muebles como ayuda para alcanzar zonas a alturas elevadas.

Tools overview

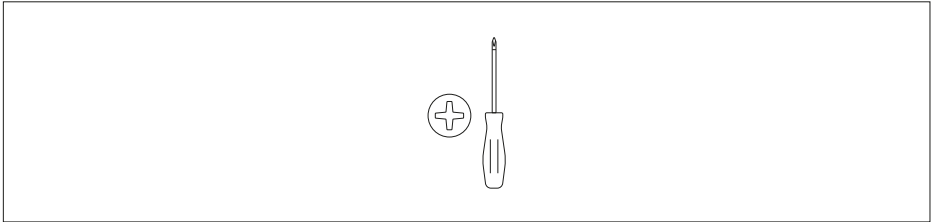

Fittings and product parts

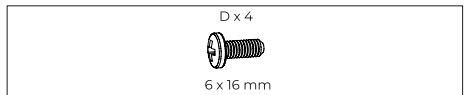
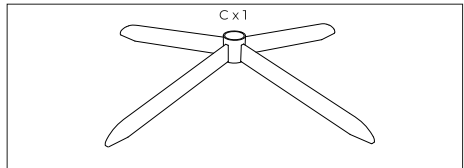
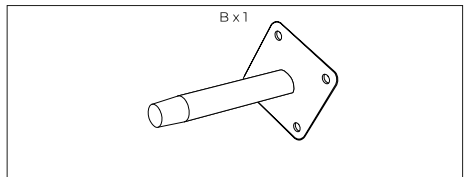
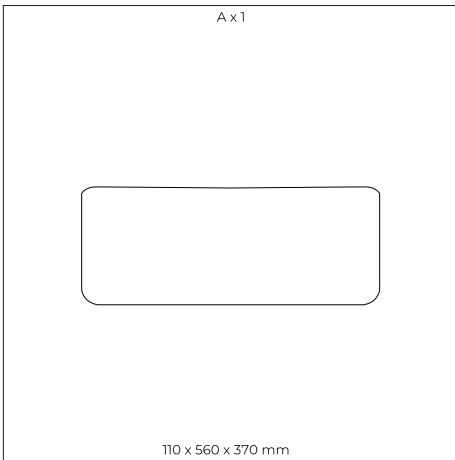

STEP 01

Tools & Special requirements

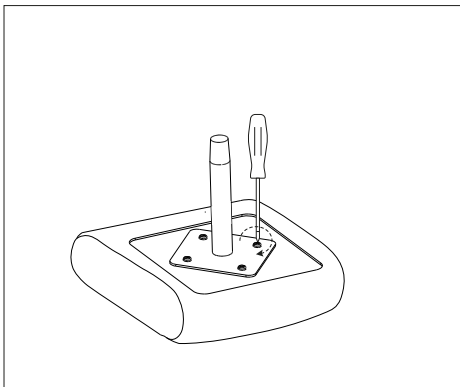
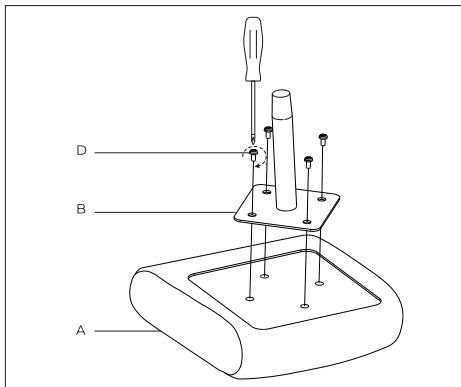
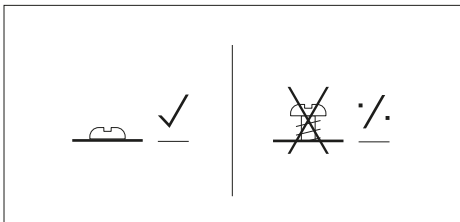
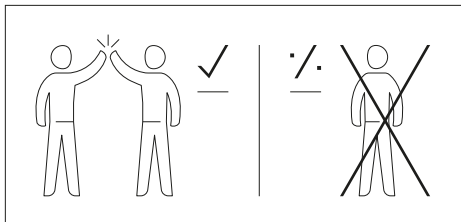

STEP 02

